

Chapter 7A compliant: Tested and listed to ASTM2886.
OSFM BML listing: 8165-2192, ICC-ESL listing: 1300

1 Hour Fire Rated, ICC-ESL listing: 1299. **Canadian Compliance** : ICC-ESL: 1455 [CAN/ULC-S101-14]

WWW.VULCANVENTS.COM (916) 652-7424 info@vulcanvents.com P.O. Box 1126 Loomis, CA. 95650



1299,1300,1455



Recommended Installation:

Use EverKem 814+ intumescent firestop caulking or similar, along flanges.
For application details and installation examples, please visit www.VulcanVents.com

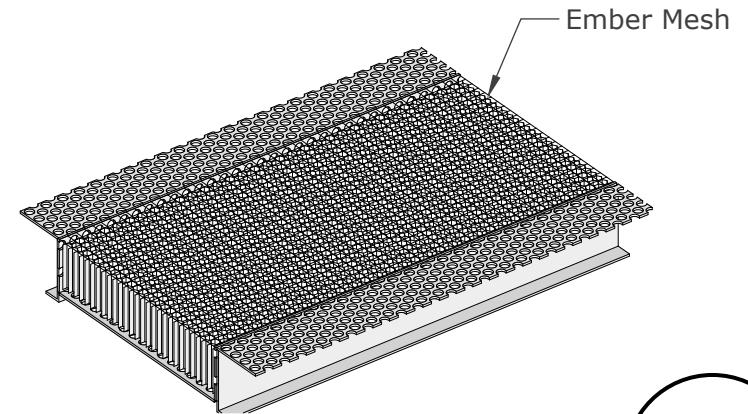
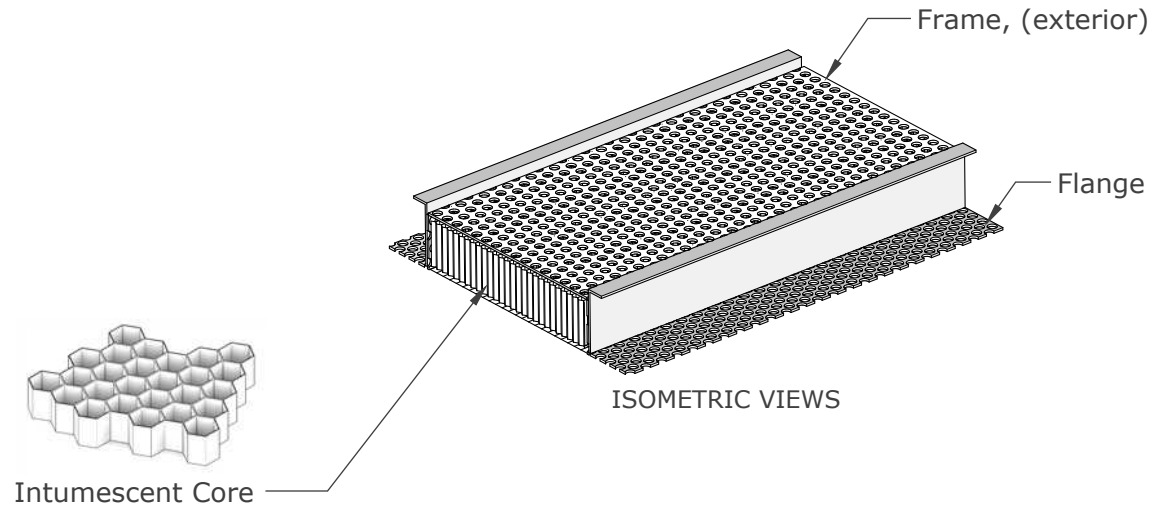
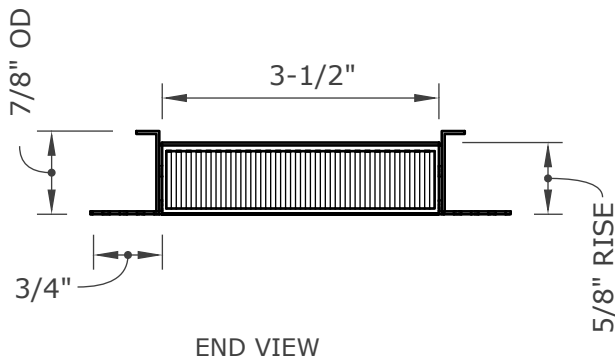
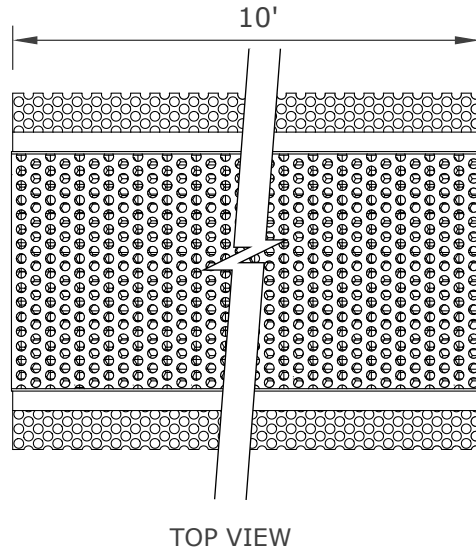

Proudly Manufactured By:  **NEW CAL**
METALS INC.

www.newcalmetals.com

VSC35120SMC78 PRODUCT SPECIFICATION & DATA SHEET

Model Description	Continuous Vent	Flange Type	Stucco MilCor 7/8"	Frame & Flange	G90 Galvanized Perforated Steel (1/8" holes) - 24GA
Model Number	VSC35120SMC78	NFVA	168 sq. in.	Intumescent Core	5mm Hexagonal Matrix - Aluminum with intumescent coating
Model Size	3-1/2" x 120"			Ember Mesh	14 Mesh - 304 Stainless Steel

